



DediProg

# EM100Pro

## Hardware Connection and Accessory Usage



Update on 2015.Jan.

# EM100Pro Connection Scenarios

DediProg provides different methods to let users connect EM100Pro to the applications.

The common scenarios that users may face:

- ❖ SPI Flash is soldered on board (no pins header on board)
- ❖ SPI Flash is in the socket (no pins header on board)
- ❖ On board pins header compatible with SPI Flash pin out
- ❖ On board pins header compatible with SF100 pin out
- ❖ On board pins header with no standard pin out
- ❖ Hold Pin is connected to Vcc without pull up resistor



# EM100Pro pins assignment

# EM100Pro Pin out

- ❖ Signals GND, Vcc, CS, CLK, MOSI and MISO have to be connected to application.
- ❖ Two Serial Flash can be supported when the SPI bus is shared.
- ❖ **In Quad IO:** DQ0(MOSI), DQ1(MISO), DQ2 (Wp), DQ3(Hold)
- ❖ Hold signal can be connected to drive the Hold pin of the on board Serial Flash low and disable it. This is only possible if Hold pin is driven high through pull-up resistor and application is not working in quad IO mode.
- ❖ EM100Pro is monitoring application Vcc to enable or disable the SPI outputs.
  - Vcc>2.7V then SPI outputs are enabled
  - Vcc<2.7V then SPI outputs are switched in High impedance to protect the application controller

## *EM100Pro pins assignments*

19	17	15	13	11	9	7	5	3	1
GND	CTRL	CTRL	CTRL	3.3V	GND	WP1 /DQ2	MISO /DQ1	CS1	Hold2
CTRL	CTRL	3.3V	NC	Wp2	MOSI /DQ0	CLK	Hold1 /DQ3	Vcc	CS2
20	18	16	14	12	10	8	6	4	2



# **SPI Flash Soldered on Board Without Pins Header on the Board**

# Connect EM100Pro with SO Test Clip 1/2

User can connect the EM100Pro to the SPI Flash soldered on board directly by using our DediProg SO Test Clip. Work with SO8N, SO8W, SO16W.

**Caution:** If the on board Serial Flash Hold pin is directly connected to Vcc (no pull-up resistor or if the on board Serial Flash do not support the Hold pin feature (some Atmel parts), please refer to the “Hold pin management” slide. This connection is not possible in Quad IO mode.



# Connect EM100Pro with SMT Header 2/2

User can remove the SPI Flash and solder DediProg 1.27mm pitch SMT Pin Header in place of the SPI Flash. Then connect EM100Pro for SPI flash emulation or our SPI Flash reference board if trial has to be performed with real Serial Flash. Work with SO8N, SO8W, SO16W.

**Caution:** If the on board Serial Flash Hold pin is directly connected to Vcc (no pull-up resistor) then EM100Pro hold pin must be configured as floating or input in the DediProg software.



1) Remove the on board SPI Flash

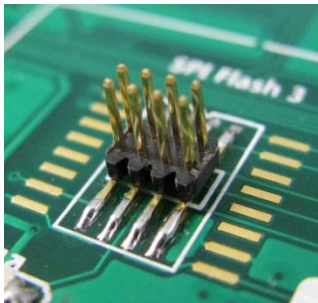

2) Solder the SMT Header

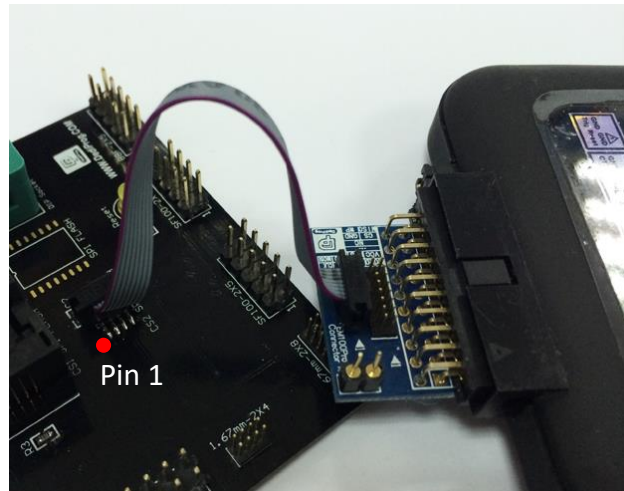

3) Connect EM100Pro for emulation

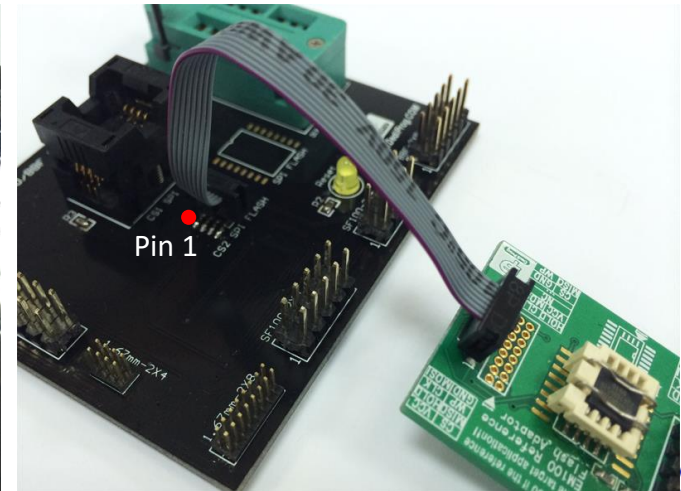

4) Connect SPI Flash reference board for trial with real Serial flash



# SPI Flash in the Engineering Socket Without Pins Header on the Board



# Connect EM100Pro with SO Engineering Socket 1/2

Engineers can solder the engineering socket in place of the Serial flash to have the option to switch easily from EM100Pro to real Serial Flash. The EM100Pro will be connected by inserting first a special SMT male header provided by DediProg in the engineering socket.

**Caution:** If the on board Serial Flash Hold pin is directly connected to Vcc (no pull-up resistor) then EM100Pro hold pin must be configured as floating or input in the DediProg software.

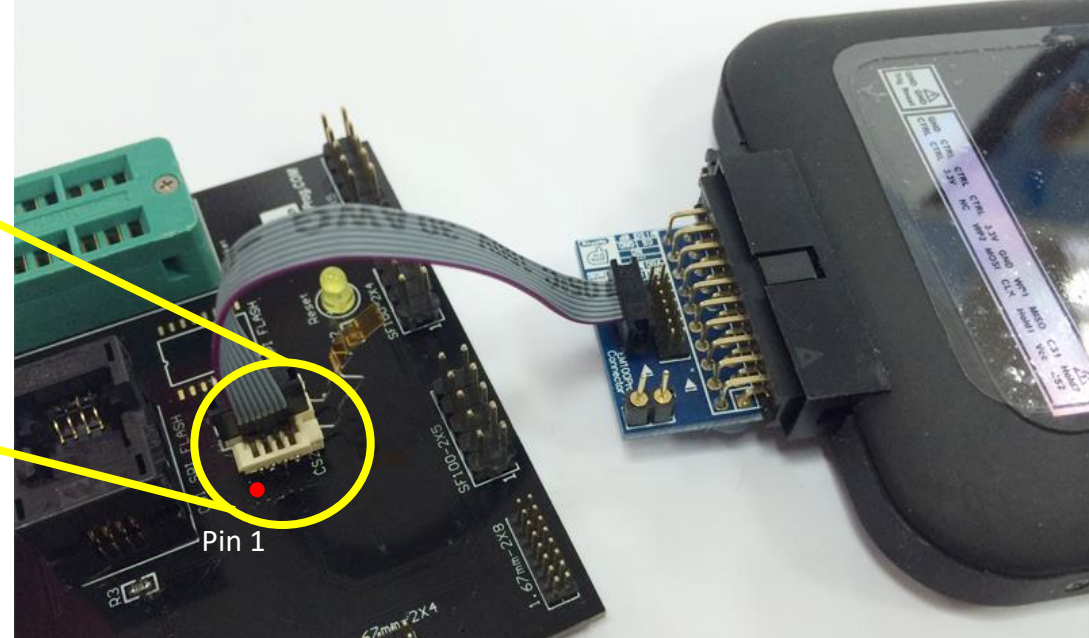
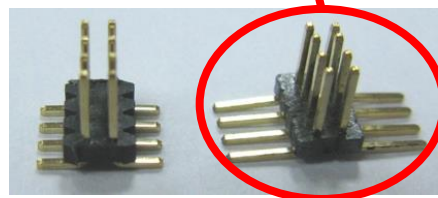
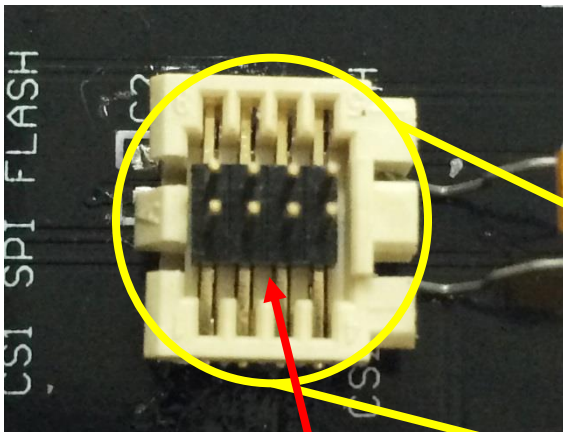

# Connect EM100Pro with SO Engineering Socket 2/2



1) Serial Flash in Engineering socket

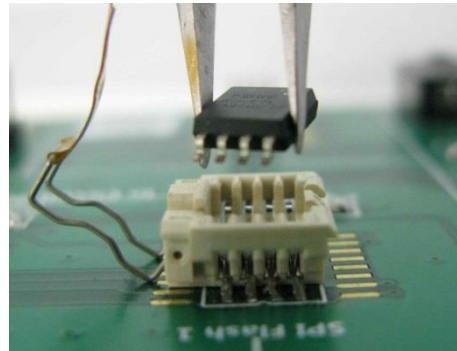

2) Remove the Serial Flash from the Engineering socket

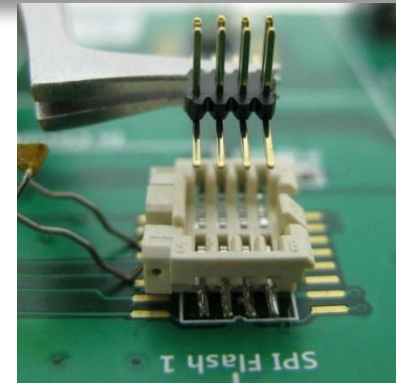

3) Insert the DediProg Special SMT connector

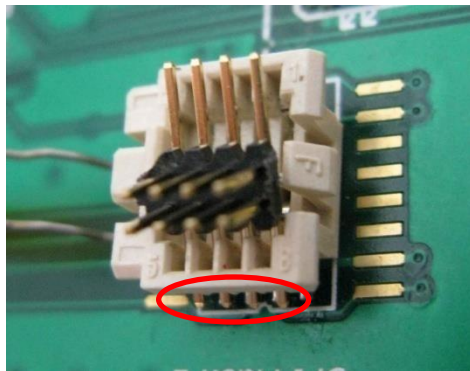

4) Slide the SMT connector between the socket contact pins and the plastic so that connector pins are shifted outside the socket then you can insert the other side.

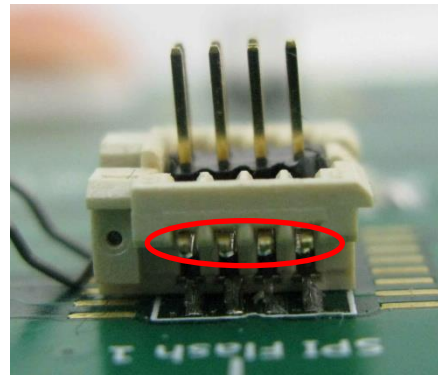

5) Plug the EM100Pro cable in the SMT connector.

# Connect EM100Pro with DIP Engineering Socket

If the application is using DIP engineering socket to insert Serial flash in DIP package  
Then EM100Pro can easily be plugged by using our DIP cable.

**Caution:** If the on board Serial Flash Hold pin is directly connected to Vcc (no pull-up resistor) then EM100Pro hold pin must be configured as floating or input in the DediProg software.

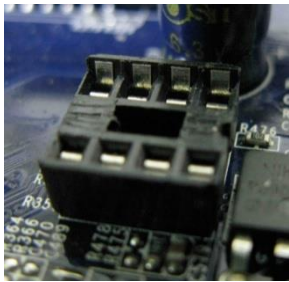

DIP engineering socket

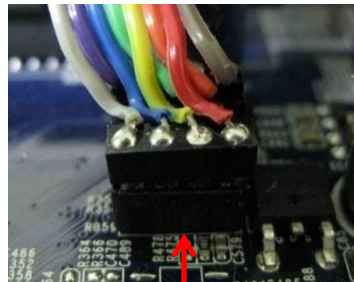

Connect EM100Pro  
With the DIP cable

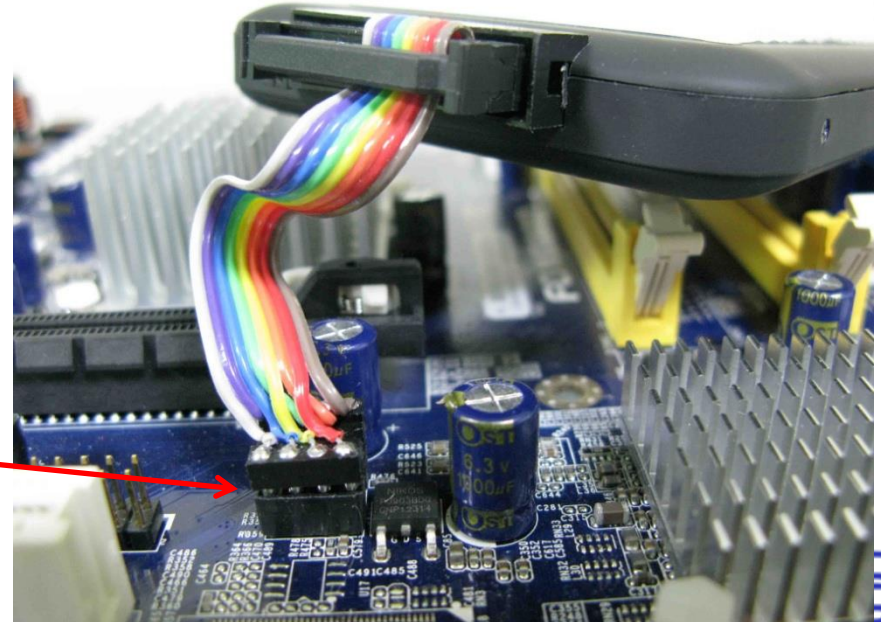



## On Board Pins Header Compatible with SPI Flash Pin Out

# Connect EM100Pro with EM100Pro Cable

If the application board has been designed with the 2.54mm pitch pin Header according to the SO8 Serial flash pin out (see table below) then EM100Pro can be connected with the standard EM100Pro cable (included in the shipment).

**Caution:** If the on board Serial Flash Hold pin is directly connected to Vcc (no pull-up resistor or if the on board Serial Flash do not support the Hold pin feature (some Atmel parts), please refer to the “Hold pin management” slide.

## Pin Header (top view)

1	CS1	Vcc	2
3	MISO/DQ1	Hold1/DQ3	4
5	WP1/DQ2	CLK	6
7	GND	MOSI/DQ0	8





## On board Pins Header Compatible with SF100 Pin Out

# Connect EM100Pro to SF100 Pin Header

If the application board has been designed with the 2.54mm pitch pin Header compatible with our SF100 pin out (see table below) then EM100Pro can be connected as follow:

1. Using the DediProg EM100Pro Split cable. If the real Serial Flash is unsoldered from the board then no extra signals has to be connected (Vcc, GND, CS, CLK, MISO and MOSI)
2. If Serial Flash is still soldered on the board then user has to connect the Serial flash Hold pin to the EM100Pro Hold signal or to the ground to disable it by using our Grabber clip.

## Pin Header (top view)

1	Vcc	GND	2
3	CS	CLK	4
5	MISO	MOSI	6

**Remark:** the pin hold is not Available on this header. On board Serial Flash will have to be disabled Like illustrated in both pictures.

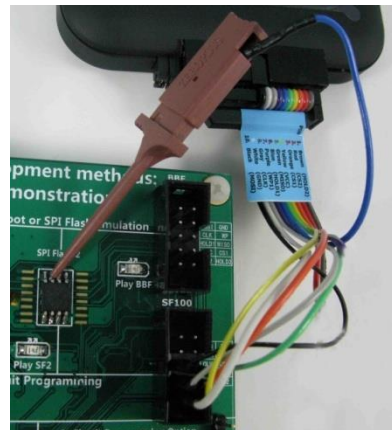

SPI Flash Hold pin Connected to EM100Pro hold signal which may be Configured low in the software.



SPI Flash Hold pin connected To SPI Flash ground pin.

**Caution:** If the on board Serial Flash Hold pin is directly connected to Vcc (no pull-up resistor or if the on board Serial Flash do not support the Hold pin feature (some Atmel parts), please refer to the “Hold pin management” slide.



## Not standard On Board Pins Header



# Connect EM100Pro to Not Standard Pin Header

If the on board header is not standard then user can use our EM100Pro split cable for adaptation. Pin header must provide at least Vcc, Gnd, CS, CLK, MISO and MOSI. If the on board Serial Flash is still on the board then Hold pin need to be used to disable it.

**Caution:** If the on board Serial Flash Hold pin is directly connected to Vcc (no pull-up resistor or if the on board Serial Flash do not support the Hold pin feature (some Atmel parts), please refer to the “Hold pin management” slide.





# On Board Hold Pin Management

# On board SPI Flash Hold Pin Management 1/2

**Case 1: The Real Serial Flash is still on board when EM100Pro is connected.  
(soldered or in engineering socket).**

## 1) Hold pin is connected to Vcc through a pull-up resistor

- If EM100Pro Hold signal is connected to the application (Via pin header, SO Test Clip or grabber) then it can be used to disable the on board Serial Flash.

The EM100Pro Hold signal can be configured low in the EM100Pro software.

- If the EM100Pro Hold signal is not connected to the application then SPI flash Hold pin has to be connected to the ground with Grabber to disable it.

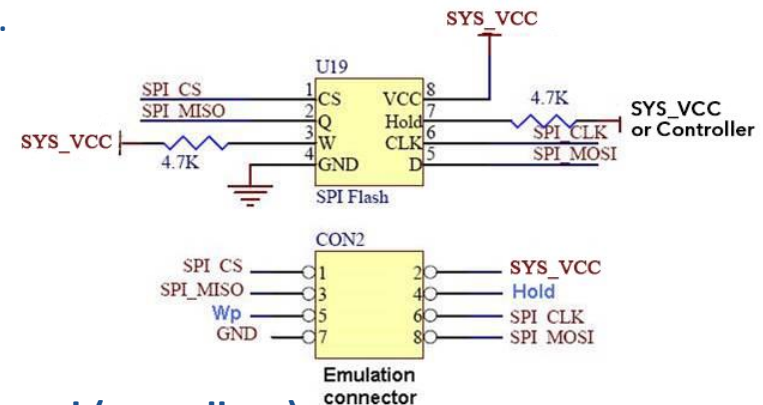

## 2) Hold pin is connected directly to Vcc in the application board (no pull-up)

In this case, the on board Serial Flash cannot be disabled and have to be removed from the board. See next slide.

## 3) SPI Flash does not support Hold feature (some Atmel parts) or used in Quad IO

In this case, the on board Serial Flash cannot be disabled and have to be removed from the board. See next slide.

# On board SPI Flash Hold Pin Management 2/2

## Case 2: The Real Serial Flash has been removed from the board.

### 1) Hold pin is connected to Vcc through a pull-up resistor

No issue, EM100Pro hold signal can be kept connected to application with any setting (driven low, Floating or input).

### 2) Hold pin is connected directly to Vcc in the application board (no Pull-up)

In this case and if EM100Pro Hold pin is connected, the EM100Pro hold pin must be configured as floating or input in the DediProg software.

The image shows two overlapping windows from the DediProg software. The 'Configure Setting' dialog box is in the foreground, with the 'Hold Pin' section selected. It contains three radio button options: 'Default Low', 'Input by default', and 'Floating by default', with 'Floating by default' being selected. The 'EM100 serial flash emulator' window is visible in the background, showing a terminal window with logs and a toolbar with buttons like 'EM100', 'Start', 'Stop', etc. A red circle highlights the 'EM100' button in the emulator's toolbar, and a red arrow points from this button to the 'Configure Setting' dialog.

# Contact us



Email : [Sales@dediprog.com](mailto:Sales@dediprog.com)